

DF-G2 High Speed Expert™ Dual Display Small Object Counter



Quick Start Guide

Advanced sensor with dual digital displays for small object counting applications

For complete technical information about this product, including dimensions, accessories, and specifications, see www.bannerengineering.com and search 178236.



WARNING: Not To Be Used for Personnel Protection

Never use this device as a sensing device for personnel protection. Doing so could lead to serious injury or death. This device does not include the self-checking redundant circuitry necessary to allow its use in personnel safety applications. A sensor failure or malfunction can cause either an energized or de-energized sensor output condition.

Overview

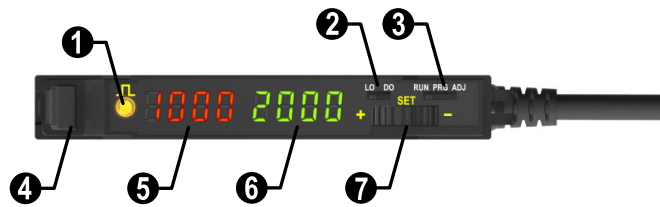

Figure 1. DF-G2 Model Features

1	Output LED
2	LO/DO Switch
3	RUN/PRG/ADJ Mode Switch
4	Lever Action Fiber Clamp
5	Red Signal Level
6	Green Threshold
7	+ /SET/ - Rocker Button

Models

Model	Outputs	Connector ¹
DF-G2-NC-2M	Single NPN, plus Health Mode output	2 m (6.5 ft) cable, 5-wire
DF-G2-PC-2M	Single PNP, plus Health Mode output	
DF-G2-NC-Q5	Single NPN, plus Health Mode output	150 mm (6 in) PVC pigtail, M12 Euro QD connector, 5-pin
DF-G2-PC-Q5	Single PNP, plus Health Mode output	
DF-G2-NC-Q7	Single NPN, plus Health Mode output	Integral M8 Pico QD connector, 6-pin
DF-G2-PC-Q7	Single PNP, plus Health Mode output	

¹ Connector options:

- A model with a QD connector requires a mating cordset
- For 9 m cable, change the suffix 2M to 9M in the 2 m model number (example, DF-G2-NC-9M)
- For 150 mm (6 in) PVC pigtail, M8 Pico QD connector, 6-pin change the suffix 2M to Q3 in the 2 m model number (example, DF-G2-NC-Q3)



Fiber Optic Arrays			
Models ²	Detection Window Dimensions	Fiber Exit	Minimum Object Size ³
PFCVA-10X25-S	10 mm x 25 mm	Side exit	1.5 mm
PFCVA-10X25-E		End exit	
PFCVA-25X25-S	25 mm x 25 mm	Side exit	3 mm
PFCVA-25X25-E		End exit	
PFCVA-34X25-S	34 mm x 25 mm	Side exit	4 mm
PFCVA-34X25-E		End exit	

Installation Instructions

Mounting Instructions

Mount on a DIN Rail

1. Hook the DIN rail clip on the bottom of the DF-G2 over the edge of the DIN rail (1).
2. Push the DF-G2 up on the DIN rail (1).
3. Pivot the DF-G2 onto the DIN rail, pressing until it snaps into place (2).

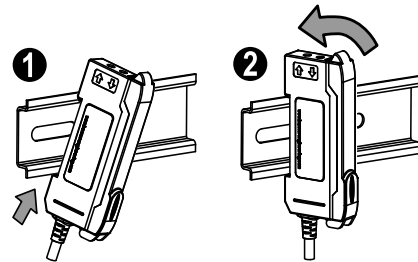

Mount to the Accessory Bracket

1. Position the DF-G2 in the SA-DIN-BRACKET.
2. Insert the supplied M3 screws.
3. Tighten the screws.

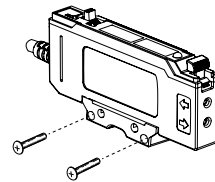

Remove from a DIN rail

1. Push the DF-G2 up on the DIN rail (1).
2. Pivot the DF-G2 away from the DIN rail and remove it (2).

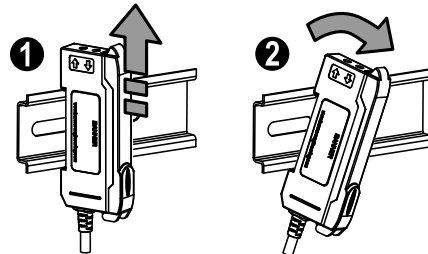

² Custom fiber arrays and mounting configurations are possible. Consult factory for assistance with your small object counting application.

³ With 2% threshold offset percentage

Installing the Fibers

Follow these steps to install glass or plastic fibers.

1. Open the dust cover.
2. Move the fiber clamp forward to unlock it.
3. Insert the fiber(s) into the fiber port(s) until they stop.
4. Move the fiber clamp backward to lock the fiber(s).
5. Close the dust cover.

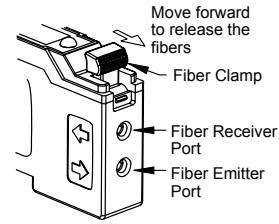

Fiber Adapters



NOTE: If a thin fiber with less than 2.2 mm outer diameter is used, install the fiber adapter provided with the fiber assembly to ensure a reliable fit in the fiber holder. Banner includes the adapters with all fiber assemblies.

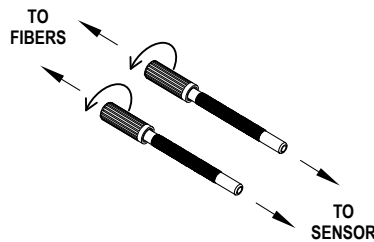

Fiber Outer Diameter (mm)	Adapter Color
Ø 1.0	Black
Ø 1.3	Red
Ø 2.2	No adapter needed

When connecting coaxial-type fiber assemblies to the amplifier, install the solid core fiber to the LED emitting port, and the multi-core fiber to the PD receiving port for most reliable detection.

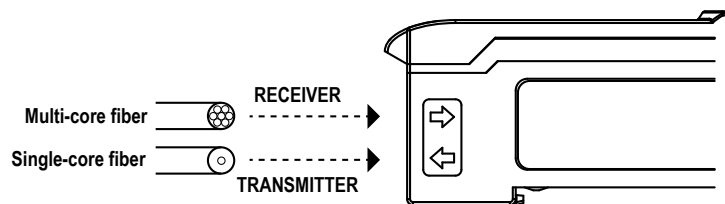

Wiring Diagrams

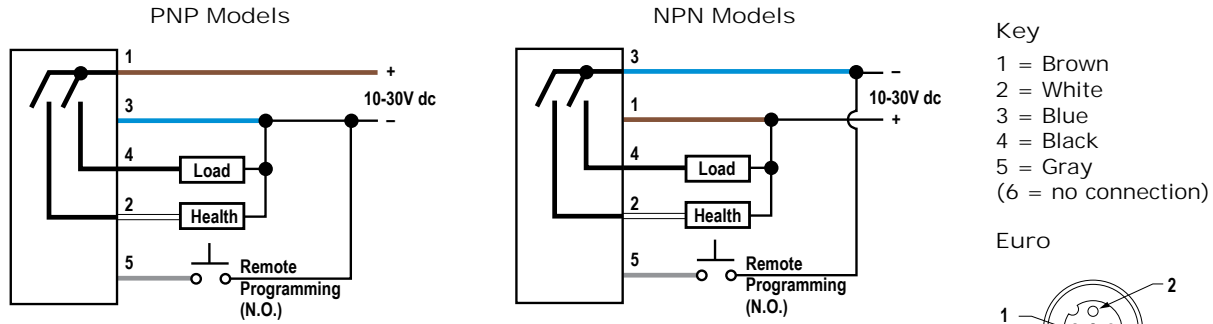

NOTE: Open lead wires must be connected to a terminal block.

Key

- 1 = Brown
- 2 = White
- 3 = Blue
- 4 = Black
- 5 = Gray
- (6 = no connection)

Euro

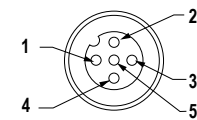

Pico

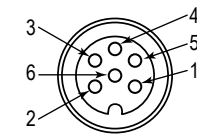

Top Panel Interface

Opening the dust cover provides access to the top panel interface. The top panel interface consists of the RUN/PRG/ADJ mode switch, LO/DO switch, +/-SET/- rocker button, dual red/green digital displays, and output LED.

RUN/PRG/ADJ Mode Switch



The RUN/PRG/ADJ mode switch puts the sensor in RUN, PRG (Program), or ADJ (Adjust) mode. RUN mode allows the sensor to operate normally and prevents unintentional programming changes via the +/-SET/- button. PRG mode allows the sensor to be programmed through the display driven programming menu (see Program Mode below). ADJ mode allows the user to perform Expert TEACH/SET methods and Manual Adjust (see Adjust Mode below).

LO/DO Switch



The LO/DO switch selects Light Operate or Dark Operate mode. In Light Operate mode, the output is ON when the sensing condition is above the threshold (for Window SET, the output is ON when the sensing condition is inside the window). In Dark Operate mode, the output is ON when the sensing condition is below the threshold (for Window SET, the output is ON when the sensing condition is outside the window).

+/-SET/- Rocker Button

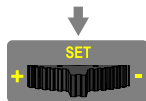

The +/-SET/- rocker button is a 3-way button. The +/- positions are engaged by rocking the button left/right. The SET position is engaged by clicking down the button while the rocker is in the middle position. All three button positions are used during PRG mode to navigate the display driven programming menu. During ADJ mode, SET is used to perform TEACH/SET methods. The rocker button is disabled during RUN mode, except when using Window SET, see [Window SET](#) on page 6.

Red/Green Digital Displays



During RUN and ADJ mode, the Red display shows the signal level and the Green display shows the threshold or the total counts. During PRG mode, both displays are used to navigate the display driven programming menu.



Output LED

The output LED provides a visible indication when the output is activated.

Operating Instructions

Remote Input

For more information about how to perform TEACH/SET methods and to program the sensor remotely, see www.bannerengineering.com and search 178236.

Run Mode



Run mode allows the sensor to operate normally and prevents unintentional programming changes. The +/SET/- rocker button is disabled during RUN mode, except when using Window SET, see [Window SET](#) on page 6.

In RUN Mode, the SET function of the +/SET/- rocker button allows the user to toggle between the threshold center value and the total number of counts on the Green display. If the Totalizer function is enabled, the total counts value increments to the programmed value and then starts over at 0. If the Totalizer function is disabled, the total counts value increments to 9999 and then starts over at 0. Changing any operational setting causes the total counts value to reset to 0.

Program Mode

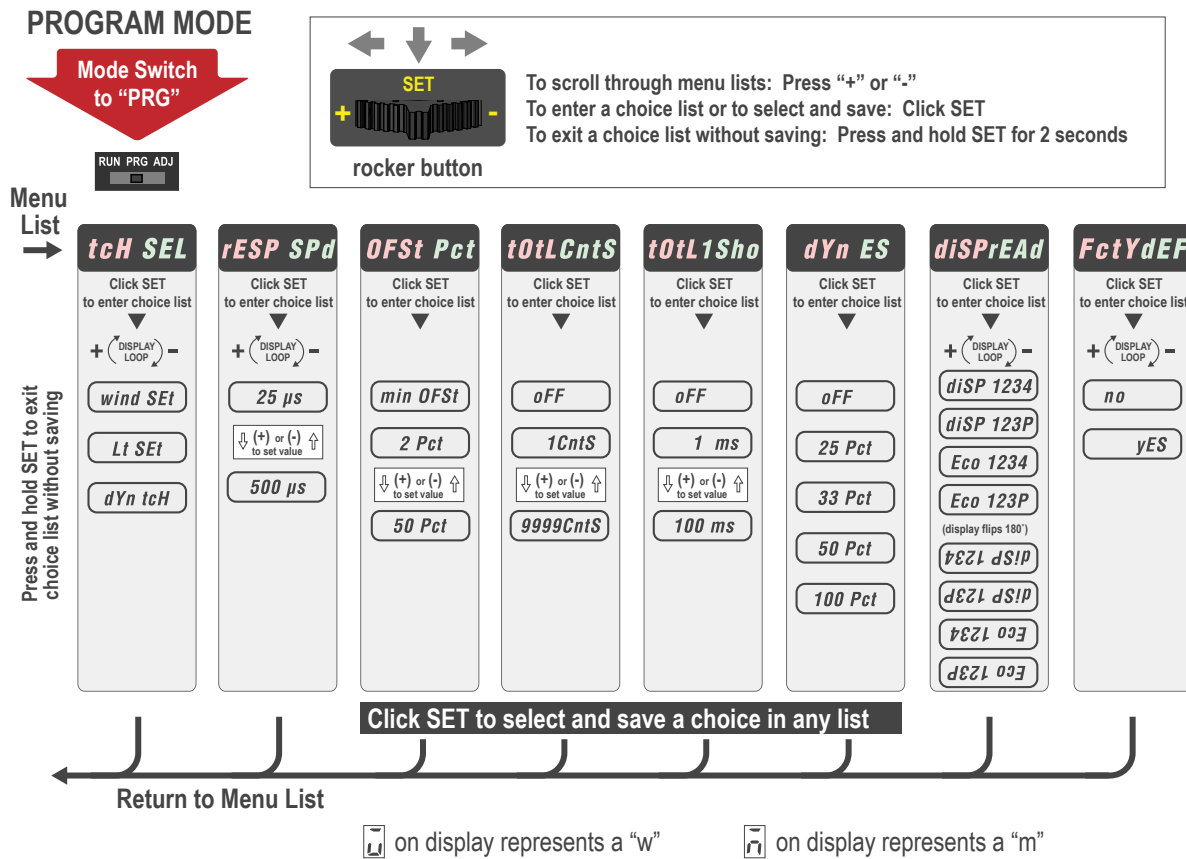
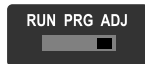

Figure 2.

Program (PRG) mode allows the following settings to be programmed in the DF-G2

Factory Default Settings:

Setting	Factory Default
Threshold	3700 (typical)
TEACH Selection	Window SET
Response Speed	Standard: 250 μ s
Offset Percent	2%
Totalizer Counts	OFF
Totalizer One-Shot	OFF
Dynamic Event Stretcher	50%
Display Readout	Numeric, ECO disabled, Normal Orientation



Adjust Mode

Sliding the RUN/PRG/ADJ mode switch to the ADJ position allows the user to perform Expert TEACH/SET methods.

Window SET

- Sets window thresholds that extend a programmable % offset above and below the presented condition
- All other conditions (lighter or darker) cause the output to change state
- Recommended for applications where a product may not always appear in the same place, or when other signals may appear
- See Program Mode in the user's manual for programming the Offset Percent setting (to increase/decrease the window size)

A single sensing condition is presented, and the sensor positions window thresholds a programmable % offset above and below the presented condition. In LO mode, Window SET designates a sensing window with the Output ON condition inside the window, and the Output OFF conditions outside the window (see [Figure 3](#) on page 6).

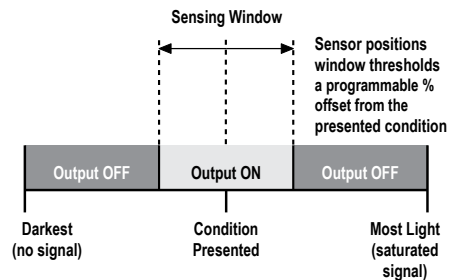

Figure 3. Window SET (Light Operate shown)

Output ON and OFF conditions can be reversed using the LO/DO switch (see LO/DO Switch in [Top Panel Interface](#) on page 4).



Window SET

Follow these steps to perform a Window SET:









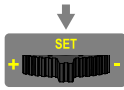

Note: TEACH Selection must be programmed to Window SET (see [Program Mode](#) on page 5)

1. Enter Adjust Mode

Method	Action	Result
SET Button ⁴	Set Mode switch to ADJ 	Display: Red - Signal Level; Green - Threshold 
Remote Input ⁵	No action required; sensor is ready for Window SET method	

2. SET Sensing Condition

Method	Action	Result
SET Button	<ul style="list-style-type: none"> Present sensing condition Click the SET rocker button  	<p><u>Threshold Condition Accepted</u></p> <p>Displays read "wI nd SET" then alternate "PASS" with % Offset⁶; Sensor returns to Adjust mode</p>    <p><u>Threshold Condition Not Accepted</u></p> <p>Displays read "wI nd SET" then alternate "FAIL" with minimum % Offset⁶ for sensing condition; Sensor returns to Adjust mode</p>   
Remote Input	<ul style="list-style-type: none"> Present sensing condition Single-pulse the remote input  	

3. Return to RUN Mode

Method	Action	Result
SET Button	Move Mode switch to Run 	Display: Red - Signal Level; Green - Window Center (see Figure 4 on page 7 for instructions on how to display upper and lower thresholds)
Remote Input	No action required; sensor returns to Run mode automatically	

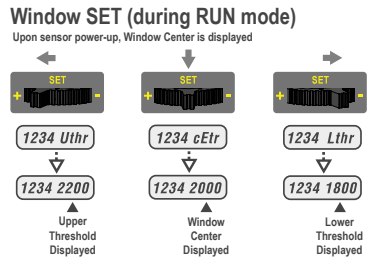

Figure 4. Upper and Lower Thresholds

⁴ SET Button: 0.04 seconds ≤ "Click" ≤ 0.8 seconds
⁵ Remote Input: 0.04 seconds ≤ T ≤ 0.8 seconds
⁶ See [Troubleshooting](#) on page 12 for more explanation of the % Offset displayed after the Window SET method

Light SET

- Sets a threshold a programmable % offset below the presented condition
- Changes output state on any condition darker than the threshold condition
- Recommended for applications where only one condition is known, for example a stable light background with varying darker targets
- See [Program Mode](#) on page 5 for programming the Offset Percent setting

A single sensing condition is presented, and the sensor positions a threshold a programmable % offset below the presented condition. When a condition darker than the threshold is sensed, the output either turns ON or OFF, depending on the LO/DO setting (see LO/DO Switch in [Top Panel Interface](#) on page 4).

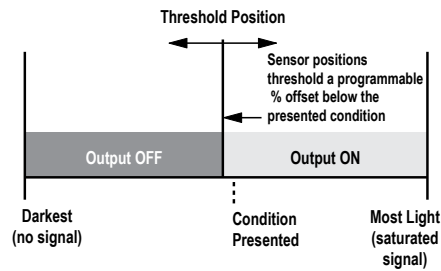

Figure 5. Light SET (Light Operate shown)

Light SET

Follow these steps to perform a Light SET:



Note: TEACH Selection must be programmed to Lt SEt (see [Program Mode](#) on page 5)

1. Enter Adjust Mode

Method	Action	Result
SET Button ⁷	Set Mode switch to ADJ	Display: Red - Signal Level; Green - Threshold
Remote Input ⁸	No action is required; sensor is ready for Light SET method	

2. SET Sensing Condition

⁷ SET Button: 0.04 seconds ≤ "Click" ≤ 0.8 seconds
⁸ Remote Input: 0.04 seconds ≤ T ≤ 0.8 seconds

Method	Action	Result
SET Button	<ul style="list-style-type: none"> Present sensing condition Click the SET rocker button 	<p><u>Threshold Condition Accepted</u></p> <p>Displays read "Lt SET" then alternate "PASS" with % Offset⁹; Sensor returns to Adjust mode</p> 
Remote Input	<ul style="list-style-type: none"> Present sensing condition Single-pulse the remote input 	<p><u>Threshold Condition Not Accepted</u></p> <p>Displays read "Lt SET" then alternate "FAIL" with minimum % Offset⁹ for sensing condition; Sensor returns to Adjust mode</p> 

3. Return to RUN Mode

Method	Action	Result
SET Button	Move Mode switch to RUN	Display: Red - Signal Level; Green - Threshold
Remote Input	No action required; sensor returns to RUN mode automatically	

Dynamic TEACH

- Teaches on-the-fly
- Establishes a single switching threshold

Dynamic TEACH is best used when a machine or process may not be stopped for teaching. The sensor learns during actual sensing conditions, taking multiple samples of the light and dark conditions and automatically setting the threshold at the optimum level (see [Figure 6](#) on page 9).

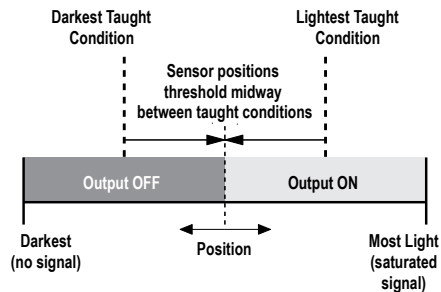

Figure 6. Dynamic TEACH (Light Operate shown)

The output ON and OFF conditions can be reversed using the LO/DO switch (see LO/DO Switch in [Top Panel Interface](#) on page 4).

Dynamic TEACH



⁹ See [Troubleshooting](#) on page 12 for more explanation of the % Offset displayed after the Light SET method

Follow these steps to perform a Dynamic TEACH:





NOTE: TEACH Selection must be programmed to dYn tch (see *Program Mode* on page 5)

1. Enter Adjust Mode.

Method	Action	Result
SET Button ¹⁰	Set Mode switch to ADJ 	Display: Red - Signal Level; Green - Threshold 
Remote Input ¹¹	No action required; sensor is ready for Dynamic TEACH method	

2. Enter Dynamic TEACH.

Method	Action	Result
SET Button	Click the SET rocker button 	Display: Flashes "dYn tch" then holds on "1234 dYn" 
Remote Input	Single-pulse remote input 	





3. Present ON and OFF Conditions.

Method	Action	Result
SET Button	Present ON and OFF conditions	Display: Red - Signal Level; Green - Threshold 
Remote Input	Present ON and OFF conditions	

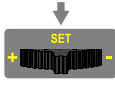

4. Exit Dynamic TEACH.

¹⁰ SET Button: 0.04 seconds ≤ "Click" ≤ 0.8 seconds

¹¹ Remote Input: 0.04 seconds ≤ T ≤ 0.8 seconds

Method	Action	Result
SET Button	Click the SET rocker button	 <u>TEACH Accepted</u>
Remote Input	Single-pulse remote input	 Displays alternate "PASS" with % Minimum Difference ¹² , Sensor returns to Adjust mode  <u>TEACH Not Accepted</u> Displays alternate "FAIL" with % Minimum Difference ¹² , Sensor returns to Adjust mode 

5. Return to RUN Mode.

Method	Action	Result
SET Button	Move Mode switch to RUN	 Display: Red - Signal Level; Green - Threshold 
Remote Input	No action required; sensor returns to RUN mode automatically	

¹² See [Troubleshooting](#) on page 12 for more explanation of the % Minimum Difference displayed after the Dynamic TEACH method.

Troubleshooting

Percent Minimum Difference after TEACH

The Dynamic TEACH method will flash a % minimum difference on the displays after a PASS or FAIL.

Value	PASS/FAIL	Description
0 to 99%	FAIL	The difference of the taught conditions does not meet the required minimum
100 to 300%	PASS	The difference of the taught conditions just meets/exceeds the required minimum, minor sensing variables may affect sensing reliability
300 to 600%	PASS	The difference of the taught conditions sufficiently exceeds the required minimum, minor sensing variables will not affect sensing reliability
600% +	PASS	The difference of the taught conditions greatly exceeds the required minimum, very stable operation



Percent Offset after SET

The Window and Light SET methods will flash a % offset on the displays after a PASS or FAIL.

SET Result	% Offset Meaning
PASS (with % Offset)	Displays the % offset used for the SET method
FAIL (with % Offset)	Displays the minimum required % offset necessary to PASS the SET method
FAIL (without % Offset)	Presented condition cannot be used for the SET method

Health Mode Alarm

The Health Mode Alarm alerts you when preventative maintenance becomes necessary to ensure reliable sensing. The Health Mode output 2 is Active when the system is OK and operating normally. Health Mode output 2 becomes Inactive when the system is in a marginal state because of contamination. The system still operates normally and can detect small objects, but is nearing the alarm state. When the system is completely contaminated and unable to ensure reliable sensing, the system goes into the alarm state. In the alarm state, the discrete output 1 is forced to the blocked state and can no longer be used to detect small objects.



- Threshold Alert  displays when Health Mode output 2 is inactive because of contamination. The system operates normally but is nearing the alarm state.
- Threshold Error  displays when discrete output 1 is forced to the blocked state and can no longer be used to detect small objects.

The sensor may enter Health Mode Alarm for any of these reasons:

1. When first powered up; the fiber optic array may already be contaminated
2. If the Window SET procedure fails, indicating the fiber optic array is contaminated and the sensor could not set a valid clear-state light level for reliable detection
3. If the fiber optic array is contaminated enough that the auto compensation tracking algorithm cannot sufficiently adjust the thresholds to ensure reliable detection
4. If the fiber optic array is blocked for more than 2 seconds

Return the system to normal operation by cleaning the fiber optic array and performing a Window SET to reset the clear-state light level (see [Window SET](#) on page 6).

Specifications

Sensing Beam Visible red, 635 nm	Output Response Time 25 µs 50 µs 150 µs 250 µs 500 µs
Supply Voltage 10 to 30 V dc Class 2 (10% max ripple)	Repeatability 12 µs 12 µs 30 µs 50 µs 80 µs
Power and Current Consumption (exclusive of load) Standard display mode: 960 mW, Current consumption < 40 mA at 24 V dc ECO display mode: 720 mW, Current consumption < 30 mA at 24 V dc	Construction Black ABS/polycarbonate alloy (UL94 V-0 rated) housing, clear polycarbonate cover
Supply Protection Circuitry Protected against reverse polarity and transient over-voltages	Environmental Rating IEC IEC IP50, NEMA 1
Delay at Power Up 500 milliseconds max.; outputs do not conduct during this time	Operating Conditions Temperature: -10 °C to +55 °C (+14 °F to +131 °F) Storage Temperature: -20 °C to +85 °C (-4 °F to +185 °F) Humidity: 90% at +60 °C maximum relative humidity (non-condensing)
Output Configuration 1 current sinking (NPN) or 1 current sourcing (PNP) output, depending on model, plus 1 Health Mode output	Certifications
Output Rating 100 mA maximum combined load (derate 1 mA per °C above 30 °C) OFF-state leakage current: < 5 µA at 30 V dc; ON-state saturation voltage: NPN: < 1.5 V; PNP: < 2 V	 
Output Protection Protected against output short-circuit, continuous overload, transient over-voltages, and false pulse on power up	Ind. Cont. Eq. 3TJJ
Connections PVC-jacketed 2 m or 9 m (6.5 ft or 30 ft) 4-wire integral cable or integral 4-pin Pico-style QD or Pico-style 150 mm (6 in) pigtail QD or Euro-style 150 mm (6 in) pigtail QD	

Banner Engineering Corp Limited Warranty

Banner Engineering Corp. warrants its products to be free from defects in material and workmanship for one year following the date of shipment. Banner Engineering Corp. will repair or replace, free of charge, any product of its manufacture which, at the time it is returned to the factory, is found to have been defective during the warranty period. This warranty does not cover damage or liability for misuse, abuse, or the improper application or installation of the Banner product.

THIS LIMITED WARRANTY IS EXCLUSIVE AND IN LIEU OF ALL OTHER WARRANTIES WHETHER EXPRESS OR IMPLIED (INCLUDING, WITHOUT LIMITATION, ANY WARRANTY OF MERCHANTABILITY OR FITNESS FOR A PARTICULAR PURPOSE), AND WHETHER ARISING UNDER COURSE OF PERFORMANCE, COURSE OF DEALING OR TRADE USAGE.

This Warranty is exclusive and limited to repair or, at the discretion of Banner Engineering Corp., replacement. IN NO EVENT SHALL BANNER ENGINEERING CORP. BE LIABLE TO BUYER OR ANY OTHER PERSON OR ENTITY FOR ANY EXTRA COSTS, EXPENSES, LOSSES, LOSS OF PROFITS, OR ANY INCIDENTAL, CONSEQUENTIAL OR SPECIAL DAMAGES RESULTING FROM ANY PRODUCT DEFECT OR FROM THE USE OR INABILITY TO USE THE PRODUCT, WHETHER ARISING IN CONTRACT OR WARRANTY, STATUTE, TORT, STRICT LIABILITY, NEGLIGENCE, OR OTHERWISE.

Banner Engineering Corp. reserves the right to change, modify or improve the design of the product without assuming any obligations or liabilities relating to any product previously manufactured by Banner Engineering Corp.