

▶▶▶ Industrial RTU

PRODUCT HIGHLIGHTS

- Datalogging and timestamping, trending, alarm logging, and sequence of events
- Stand alone control of remote sites IEC 61131 ISaGRAF and high level C++ programming
- Limitless multi-user connectivity; telephone, Internet, and wireless telemetry, 10/100 Ethernet plus up to 4 com ports
- Advanced communication capabilities report on exception, store & forward, peer to peer
- True open system design, Ethernet TCP, Modbus, Linux, OPC & more
- Small to large applications, scalable from 1 to 1,000+ stations
- Embedded Linux open source software, add applications, I/O drivers & much more
- An OEM's dream platform, pre-certified, add your application

PERFORMANCE SPECIFICATIONS

- Industrial powerPC (32 bit data bus)
- Operating system embedded Linux
- Dynamic memory (RAM) up to 32 Mbytes - 32bit, 0 wait states
- Program memory (Flash) up to 64 Mbytes
- Retained memory (RAM) 512K (battery-backed)
- Local I/O (on-board) 26 (see ordering info.)
- Unlimited I/O expansion
- Datalogging support
- IEC 61131 programming
- High Level C programming, Linux open source

ETHERNET PORT

- 10/100BaseTx (auto-detecting)
- RJ45 connection (auto-crossover)
- Protocols TCP/IP, ARP, UDP, ICNP, DHCP, Modbus/TCP, Sixnet, and more

SERIAL PORT

- RS485 port A & C screws (485+, 485-, GND) (2-wire half-duplex)
- RS232 port B RJ45 (TD, RD, CTS, RTS, CD, DTR, DSR, GND)
- RS232 port D screws (TD, RD, RTS)
- Protocols (master & slave) Sixnet & Modbus RTU/ASCII; many others available in Linux
- Flow control hardware, software, RTS-party (for radios and RS485)

DISCRETE INPUTS

- 12 channels (sinking or sourcing)
- Guaranteed ON voltage 9 VDC
- Maximum voltage 30 VDC
- Guaranteed OFF voltage & current 5.0 VDC & 1.5 mA DC
- Input resistance 10K Ohms
- Input current @ 24 VDC 3 mA
- Filtered ON/OFF delay 25 mS (20 Hz max. counting)
- Fast ON/OFF delay 4 mS (100 Hz max. counting)
- Count rate (channels 1 - 8) see above (10 KHz on channel 1)

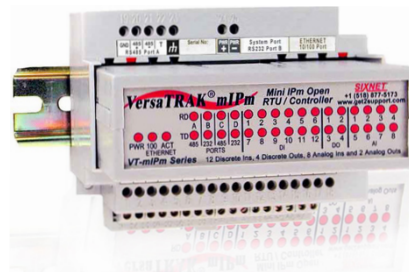

DISCRETE OUTPUTS

- Up to 8 channels (10-30 VDC)
- Maximum output per channel 1 Amp
- Maximum output per module 8 Amps
- Max. OFF state leakage 0.05 mA
- Minimum load 1 mA
- Inrush current 5 Amps (100 mS surge)
- Typical ON resistance 0.3 Ohms
- Typical ON voltage (@1A) 0.3 VDC

ANALOG INPUTS

- Up to 8 channels (4-20 mA)
- A/D resolution 16 bits (0.003%)
- Full scale accuracy +/-0.1% (@20°C)
- Span and offset temp. coef. +/-50 ppm per °C
- Input impedance 100 Ohm
- Current protection Self-resetting fuses
- DMRR (differential mode rejection) 66 dB at 50/60 Hz

ANALOG OUTPUTS

- up to 2 channels (4-20 mA)
- D/A resolution 16 bits (less than 1µA)
- Full scale accuracy (@20°C) +/- 0.02%
- Span and offset temp. coef. +/- 50 ppm per °C typical
- Max. output settling time 5 mS (to .05%)
- Load resistance range (@ +24 VDC supply) 0-750 Ohms
- Short circuit protection current limiting

ENVIRONMENTAL

- DIN rail or flat panel mount
- Input power 10-30 VDC
- Input current 100 mA @ 24 VDC (typical)
- Temperature -40 to 70°C (-40 to 85°C storage)
- Humidity 5% to 95% RH (non-condensing)
- Flammability UL 94V-0 materials
- Electrical safety UL 508, CSA C22.2/14; EN610101; (IEC1010)
- EMI emissions FCC part 15, ICES-003, Class A; EN55022; EN61326-1
- EMC immunity EN61326-1 (EN61000-4-2,3,4,6)
- Vibration IEC68-2-6
- Hazardous locations (Class 1, Div 2, Groups A,B,C,D) UL 1604, CSA C22.2/213, Genelec EN50021 Zone 2

All specifications are subject to change. Consult factory for latest info.

MECHANICAL DIMENSIONS

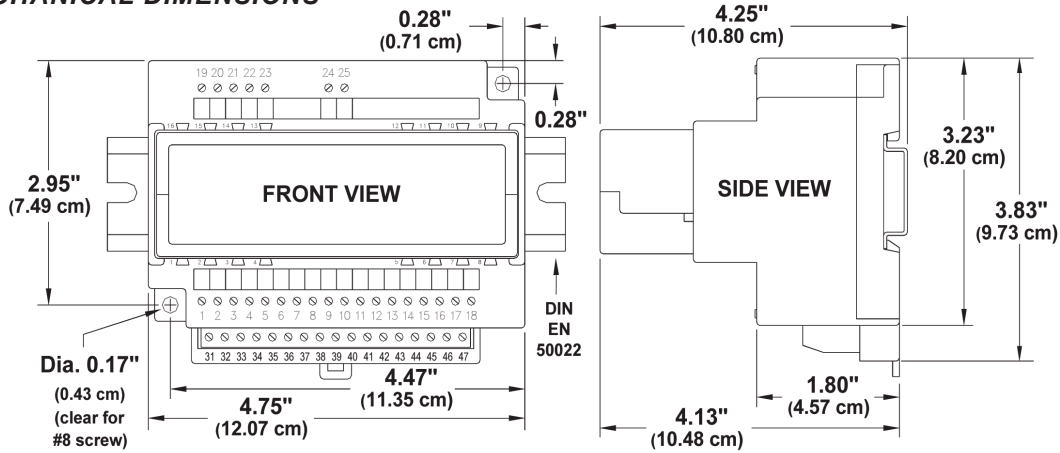

WIRING DIAGRAM

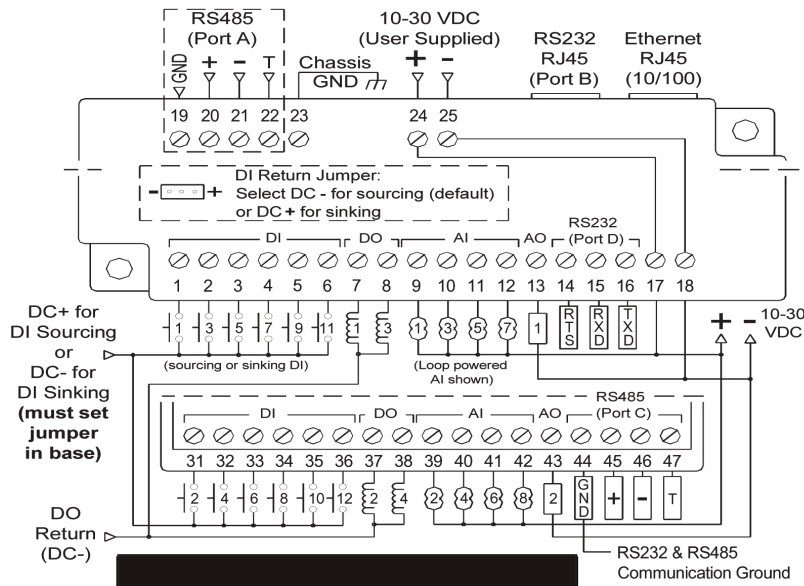

Equivalent DC Input Circuits

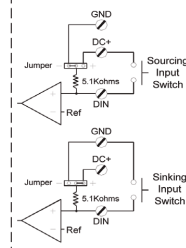

Equivalent DC Output Circuit (sourcing only)

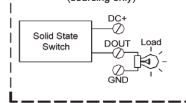

Equivalent DC Output Circuit (sinking only)

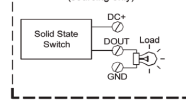

Equivalent Analog (4-20 mA) Input Circuit

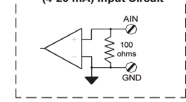

Equivalent Analog (4-20 mA) Output Circuit

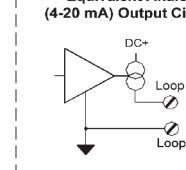

ORDERING GUIDE

Model	DI	DO	AI	AO	RS232	RS485	Ethernet
VT-MIPM-131-D	12	8	6	0	2	1	10/100
VT-MIPM-135-D	12	8	6	0	2	1	10/100
VT-MIPM-241-D	12	4	8	2	2	2	10/100
VT-MIPM-245-D	12	4	8	2	2	2	10/100



www.redlion.net

Connect. Monitor. Control.

Americas
sales@redlion.net

Asia-Pacific
asia@redlion.net

**Europe
Middle East
Africa**
europe@redlion.net

+1 (717) 767-6511

As the global experts in communication, monitoring and control for industrial automation and networking, Red Lion has been delivering innovative solutions for over forty years. Our award-winning technology enables companies worldwide to gain real-time data visibility that drives productivity. Product brands include Red Lion, N-Tron and Sixnet. With headquarters in York, Pennsylvania, the company has offices across the Americas, Asia-Pacific and Europe. For more information, please visit www.redlion.net. Red Lion is a Spectris company.